

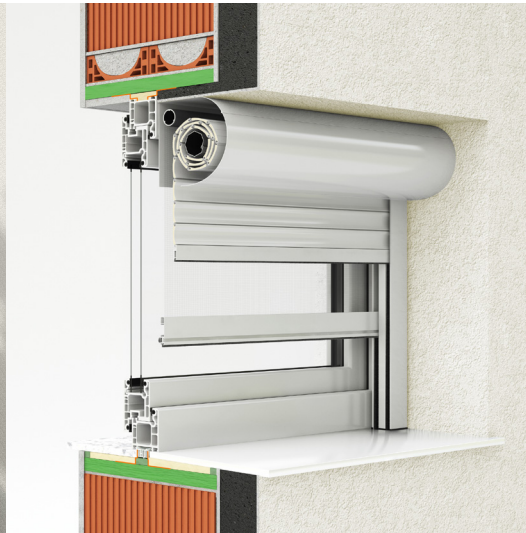

External roller shutter OVAL



- **HEAT PROTECTION**
- **ANTI-THEFT PROTECTION**
- **LIGHT REGULATION**
- **DIMMING**
- **UV PROTECTION**
- **HEATING / COOLING SAVINGS**

One of the most sophisticated mount-on visible shutters is definitely the OVAL shutter because its shape additionally contributes to a better exterior appearance. The oval box forms a completed whole with the shutters and the facade. The oval box is composed of three parts: rear, top, and front service panel, all of which are made of extruded aluminium, which adds the extra stiffness and a better appearance to the box.

SLATS | Color palette:

01 WHITE	02 D. CHOCO	03 SILVER	04 BEIGE
11 ANTICO GRIGIO	12 ANTHRACITE	14 GREY	52 DB 703

01 WHITE	02 D. CHOCO	03 SILVER	05 L. CHOCO
12 ANTHRACITE	14 RAL 9007	52 DB 703	

ALU slats are filled with insulation – polyurethane foam, standard fitted with anti-theft springs. Machine slat binding ensures a quieter and more reliable operation.

<table border="0"> <tr> <td style="border: 1px solid black; border-radius: 10px; padding: 2px;">04 BEIGE</td> <td style="border: 1px solid black; border-radius: 10px; padding: 2px;">08 GREEN</td> <td style="border: 1px solid black; border-radius: 10px; padding: 2px;">10 L. GREY</td> <td style="border: 1px solid black; border-radius: 10px; padding: 2px;">11 ANTICO GRIGIO</td> <td style="border: 1px solid black; border-radius: 10px; padding: 2px;">13 GRAPHITE</td> </tr> <tr> <td style="border: 1px solid black; border-radius: 10px; padding: 2px;">15 OCHRE</td> <td style="border: 1px solid black; border-radius: 10px; padding: 2px;">18 RAL 8017</td> <td colspan="3"></td> </tr> </table>	04 BEIGE	08 GREEN	10 L. GREY	11 ANTICO GRIGIO	13 GRAPHITE	15 OCHRE	18 RAL 8017				<table border="0"> <tr> <td style="border: 1px solid black; border-radius: 10px; padding: 2px;">06 ASH</td> <td style="border: 1px solid black; border-radius: 10px; padding: 2px;">07 WALNUT</td> <td style="border: 1px solid black; border-radius: 10px; padding: 2px;">16 GOLDEN OAK</td> </tr> <tr> <td style="border: 1px solid black; border-radius: 10px; padding: 2px;">17 WALNUT GFA</td> <td style="border: 1px solid black; border-radius: 10px; padding: 2px;">21 RAL 3011</td> <td></td> </tr> </table>	06 ASH	07 WALNUT	16 GOLDEN OAK	17 WALNUT GFA	21 RAL 3011	
04 BEIGE	08 GREEN	10 L. GREY	11 ANTICO GRIGIO	13 GRAPHITE													
15 OCHRE	18 RAL 8017																
06 ASH	07 WALNUT	16 GOLDEN OAK															
17 WALNUT GFA	21 RAL 3011																

WARNING: Certain colours on the chart may vary from original!

CABINET, GUIDERAILS, END SLAT | Color palette:

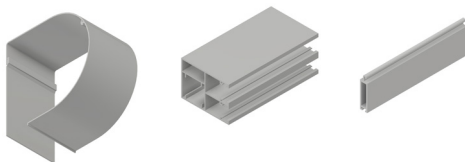

<table border="0"> <tr> <td style="border: 1px solid black; border-radius: 10px; padding: 2px;">013 WHITE</td> <td style="border: 1px solid black; border-radius: 10px; padding: 2px;">010 RAL 9006</td> <td style="border: 1px solid black; border-radius: 10px; padding: 2px;">090 RAL 9007</td> </tr> <tr> <td style="border: 1px solid black; border-radius: 10px; padding: 2px;">042 RAL 7016</td> <td style="border: 1px solid black; border-radius: 10px; padding: 2px;">066 RAL 8019</td> <td style="border: 1px solid black; border-radius: 10px; padding: 2px;">052 DB 703</td> </tr> </table>	013 WHITE	010 RAL 9006	090 RAL 9007	042 RAL 7016	066 RAL 8019	052 DB 703	<table border="0"> <tr> <td style="border: 1px solid black; border-radius: 10px; padding: 2px;">PC2 SURCHARGE</td> </tr> </table>	PC2 SURCHARGE
013 WHITE	010 RAL 9006	090 RAL 9007						
042 RAL 7016	066 RAL 8019	052 DB 703						
PC2 SURCHARGE								

WARNING: Certain colours on the chart may vary from original!



MANIPULATION:



Manipulation is possible with automaton or electrical motor. For motor operation there is the standard PLUG & PLAY function, which allows the connection of several motors to a single switch, self-adjusting positions and the safety function in the event of an obstacle.

External roller shutter OVAL



TEHNIICAL DRAWINGS | Shade details:

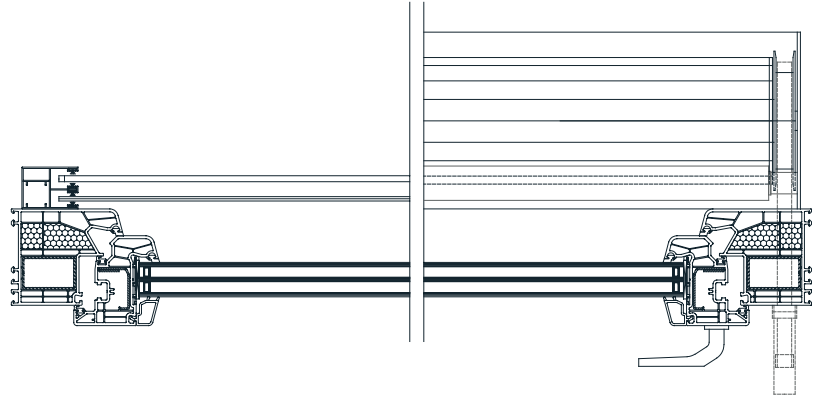
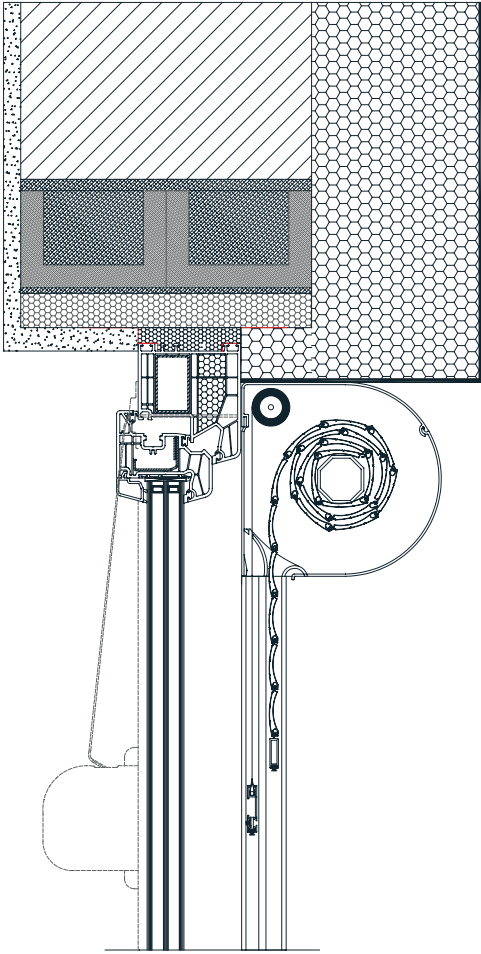

OVAL 150

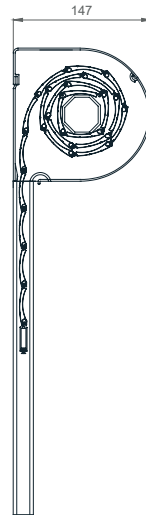

OVAL 165

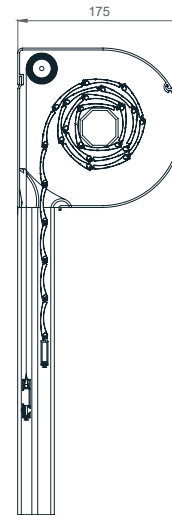

OVAL 180

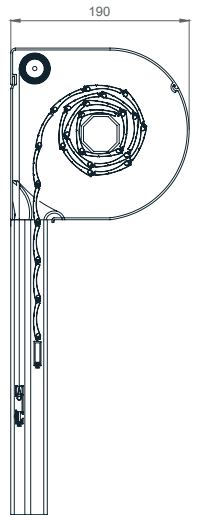

GUIDERAILS

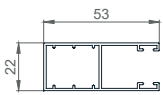

53 X 22mm

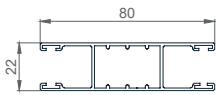

80 X 22mm

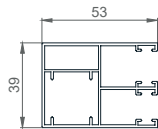

53 X 39mm

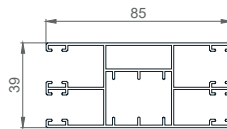

85 X 39mm

SLATS

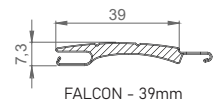

FALCON - 39mm

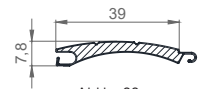

ALU - 39mm

TABLE OF BOX (CABINET) SIZES

Slat/Shaft cabinet size	FALCON / 60mm		ALU / 40mm		ALU / 60mm	
	MOS.		MOS.		MOS.	
13,7 cm	105,0	-	173,9	-	146,3	-
15,0 cm	130,0	105,0	204,9	150,8	189,9	139,9
16,5 cm	195,0	130,0	265,0	202,3	249,9	199,9
18,0 cm	245,0	210,0	319,9	255*	309,9	255*
19,0 cm	270,0	250,0	-	-	-	-
20,5 cm	-	-	407,1	*	376,2	*