

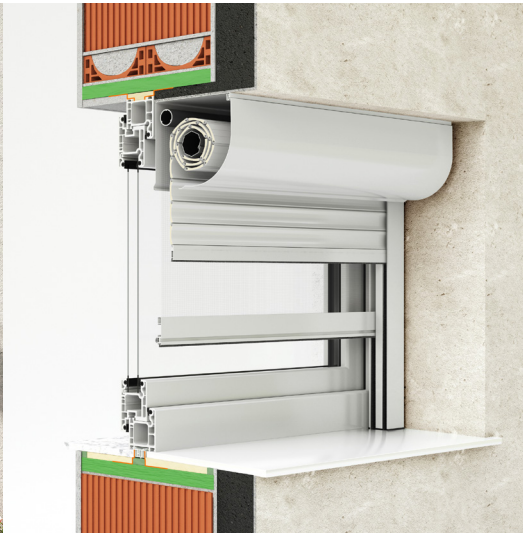

# External roller shutter Quarter-OVAL



- HEAT PROTECTION
- ANTI-THEFT PROTECTION
- LIGHT REGULATION
- DIMMING
- UV PROTECTION
- HEATING / COOLING SAVINGS

If you want to embellish the external appearance of the building, we suggest mount-on external QUARTER-OVAL roller shutters. Roller box is composed of two parts (aluminium plate): the back part, which is the same in most of the shutters, and the front curved part, which also serves as a servicing panel.

## SLATS | Color palette:

**FALCON 39mm**

01 WHITE	02 D. CHOCO	03 SILVER	04 BEIGE
11 ANTIKO GRIGIO	12 ANTHRACITE	14 GREY	52 DB 703

**ALU 39mm**

01 WHITE	02 D. CHOCO	03 SILVER	05 L. CHOCO
12 ANTHRACITE	14 RAL 9007	52 DB 703	

ALU slats are filled with insulation – polyurethane foam, standard fitted with anti-theft springs. Machine slat binding ensures a quieter and more reliable operation.

04 BEIGE	08 GREEN	10 L. GREY	11 ANTIKO GRIGIO	13 GRAPHITE
15 OCHRE	18 RAL 8017			

06 ASH	07 WALNUT	16 GOLDEN OAK
17 WALNUT GFA	21 RAL 3011	

WARNING: Certain colours on the chart may vary from original!

## CABINET, GUIDERAILS, END SLAT | Color palette:

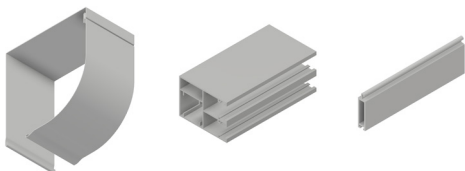

013 WHITE	010 RAL 9006	090 RAL 9007	SURCHARGE
042 RAL 7016	066 RAL 8019	052 DB 703	

WARNING: Certain colours on the chart may vary from original!



## MANIPULATION:



Manipulation is possible with automaton or electrical motor. For motor operation there is the standard PLUG & PLAY function, which allows the connection of several motors to a single switch, self-adjusting positions and the safety function in the event of an obstacle.

# External roller shutter Quarter-OVAL



## TEHNICAL DRAWINGS | Shade details:

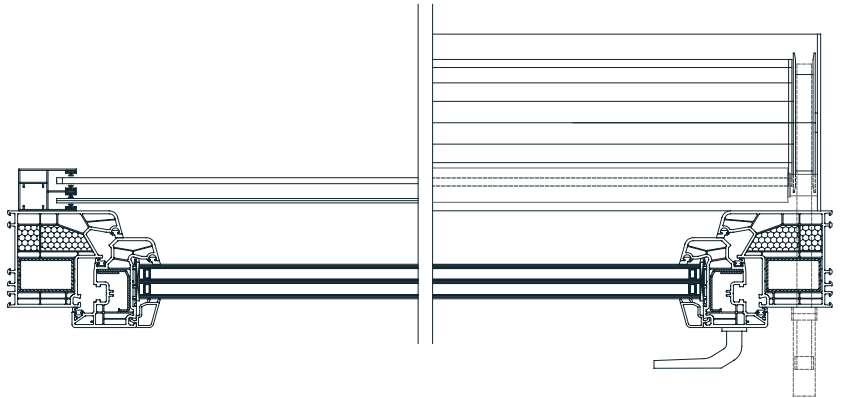
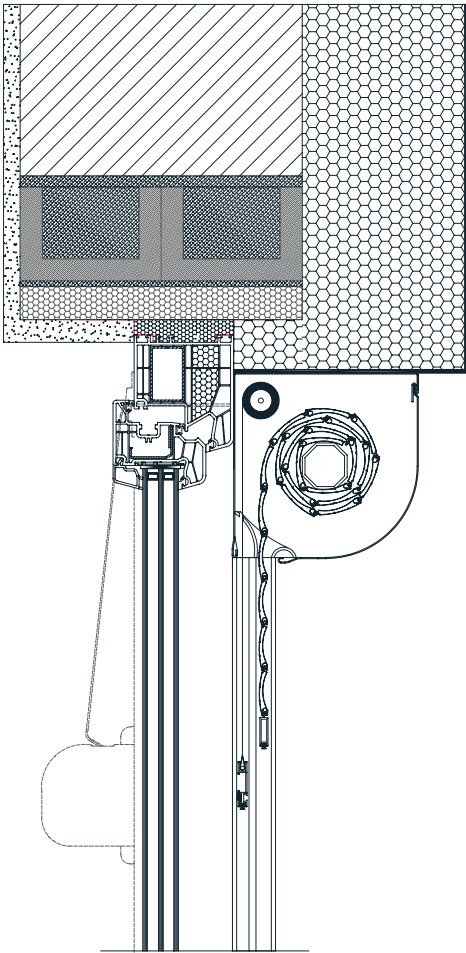

QUARTER-OVAL 150

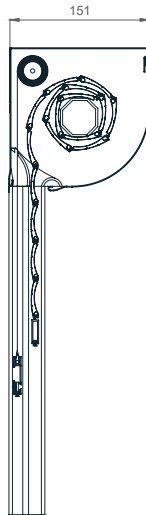

QUARTER-OVAL 180

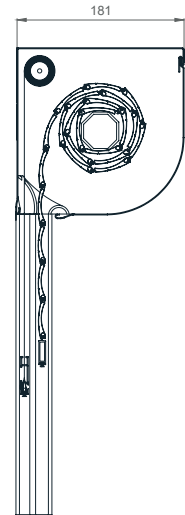

### GUIDERAILS

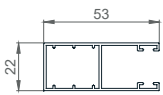

53 X 22mm

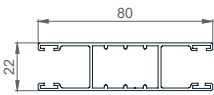

80 X 22mm

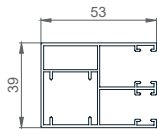

53 X 39mm

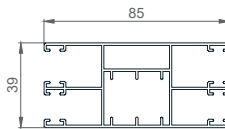

85 X 39mm

### SLATS

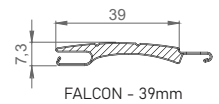

FALCON - 39mm

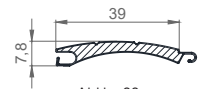

ALU - 39mm

### TABLE OF BOX (CABINET) SIZES

Slat/Shaft cabinet size	FALCON / 60mm		ALU / 40mm		ALU / 60mm	
		MOS.		MOS.		MOS.
13,7 cm	105,0	-	173,9	-	146,3	-
15,0 cm	130,0	105,0	204,9	150,8	189,9	139,9
16,5 cm	195,0	130,0	265,0	202,3	249,9	199,9
18,0 cm	245,0	210,0	319,9	255*	309,9	255*
19,0 cm	270,0	250,0	-	-	-	-
20,5 cm	-	-	407,1	*	376,2	*