

KRPAN External Venetian Blind - visible mask

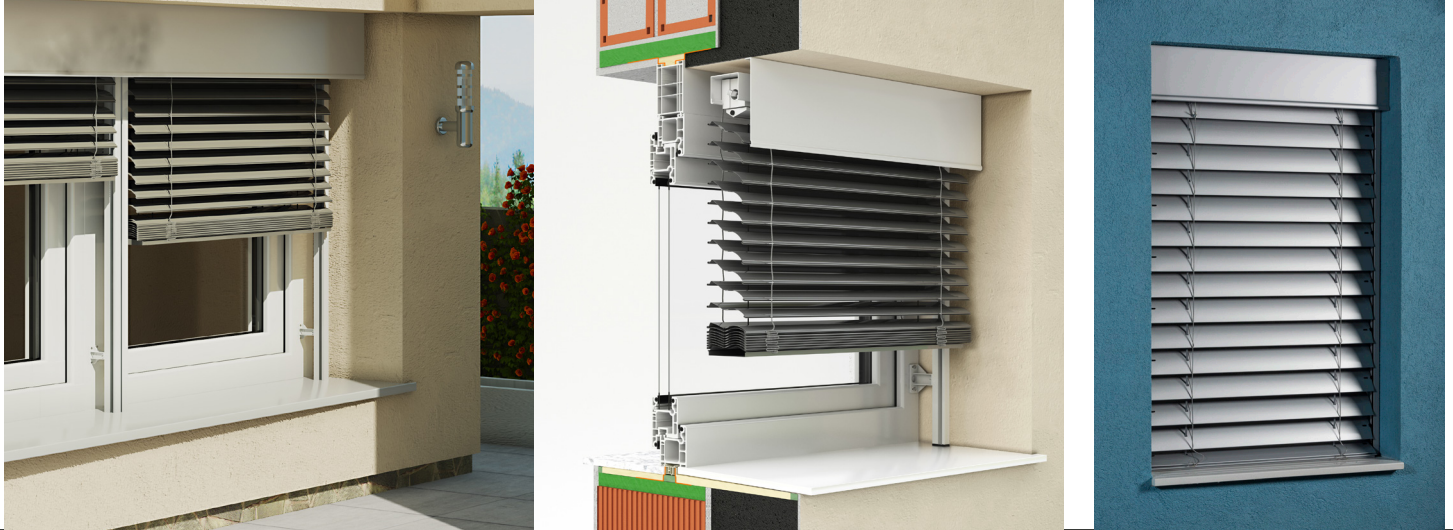

- **COMPACT AND MODERN APPEARANCE**
- **HEAT PROTECTION**
- **LIGHT REGULATION**
- **NUMEROUS COLOR AND DESIGN COMBINATIONS**
- **ENERGY SAVINGS IN COOLING/HEATING**

KRPAN External Venetian Blind with visible ALU casing, ensuring compactness and durability of the casing. Guides aesthetically finished with PVC end caps and fixed brushes for quieter operation. Roller insect screens include a brake for smoother lifting.

SLATS | Color Palette:

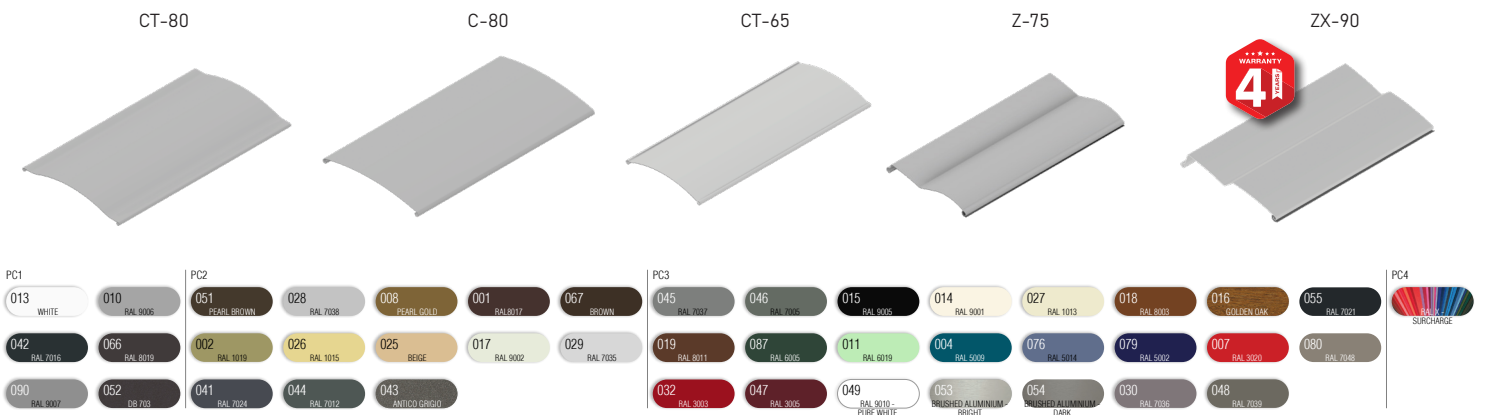

WARNING: Some colors on the palette may vary from the original!

MASK, GUIDES, END BAR | Color Palette:

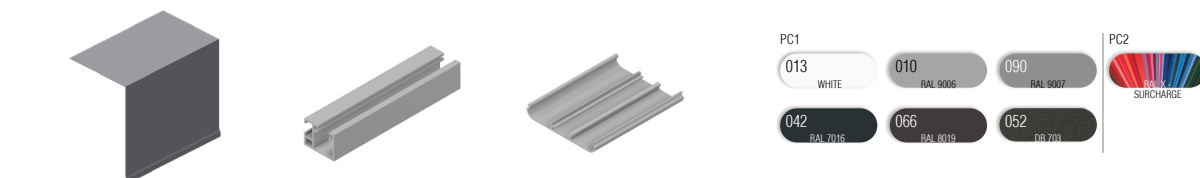

WARNING: Some colors on the palette may vary from the original!

MANIPULATION:



Control via a single lever or motors. For motorized drives, the PLUG & PLAY function is standard, enabling the connection of multiple motors to one switch, self-adjusting positions, and a safety feature in case of encountering an obstacle. The ADC controller offers wireless control of blinds.



KRPAN External Venetian Blind - visible mask

TECHNICAL DRAWINGS | Shade Details:

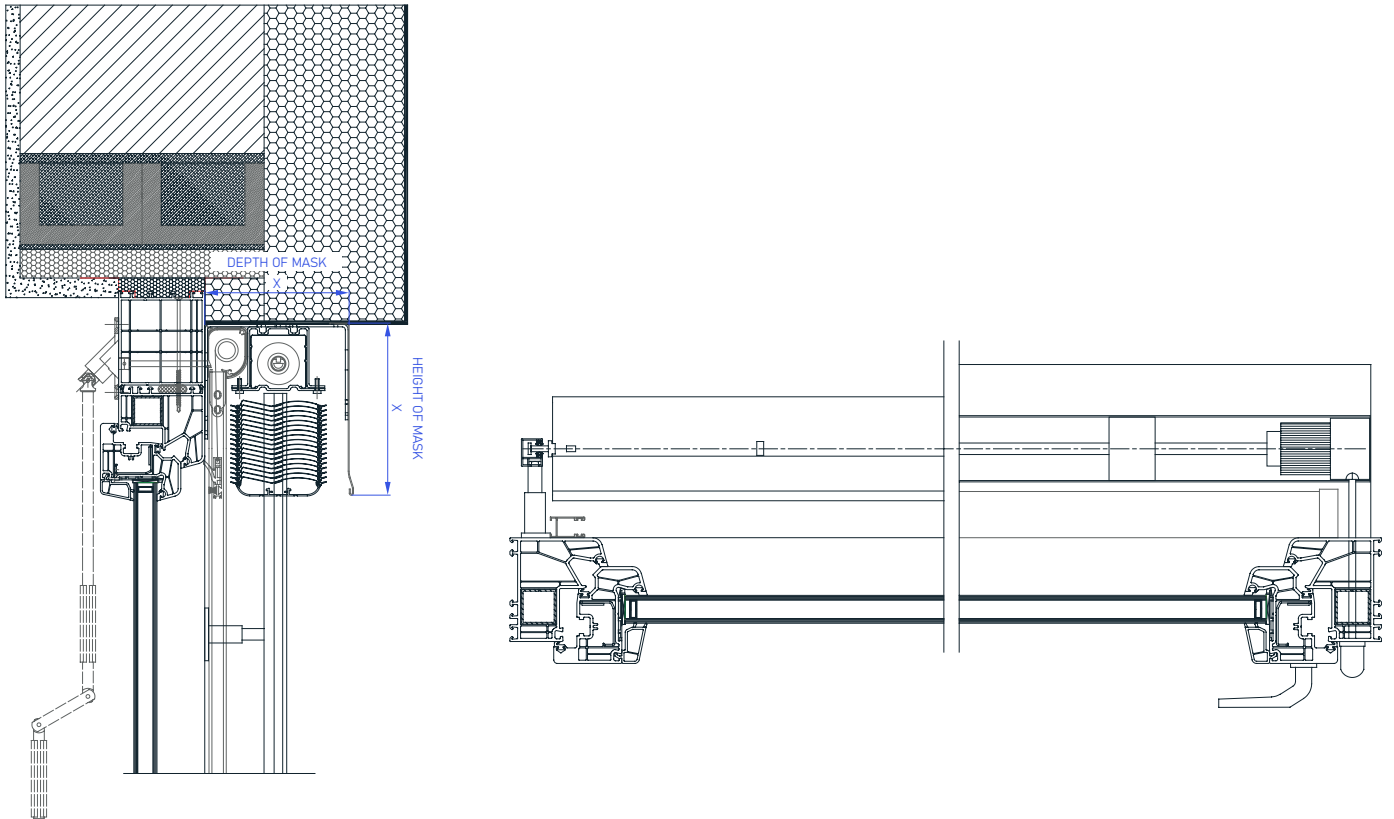

SLATS

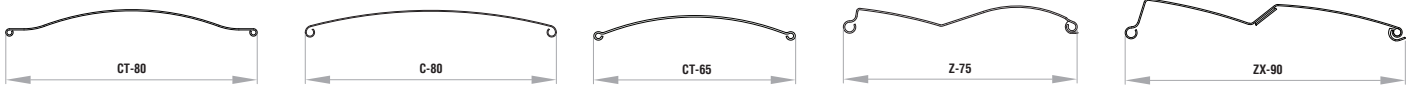

BRACKETS

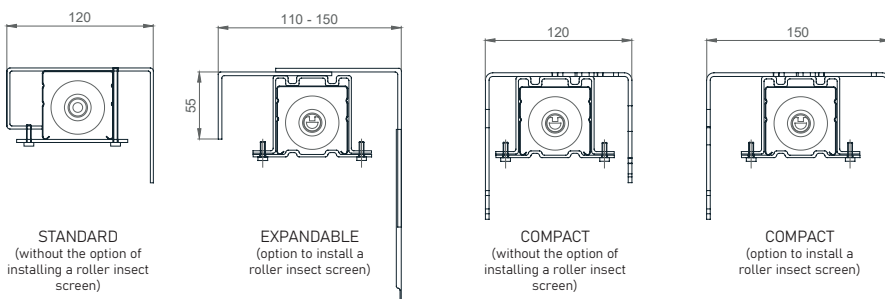

The size of the bracket depends on the **DEPTH OF THE MASK!**

SPACER

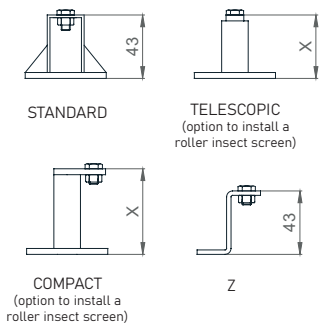

HINGES

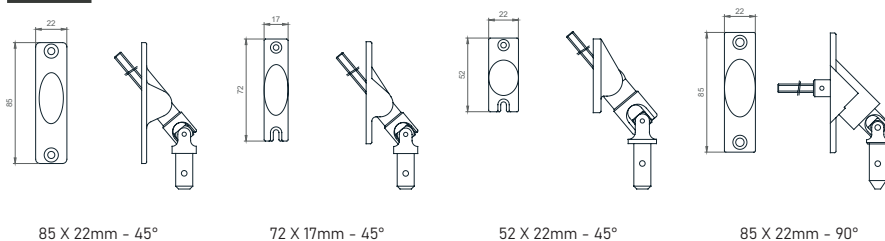

GUIDES

